

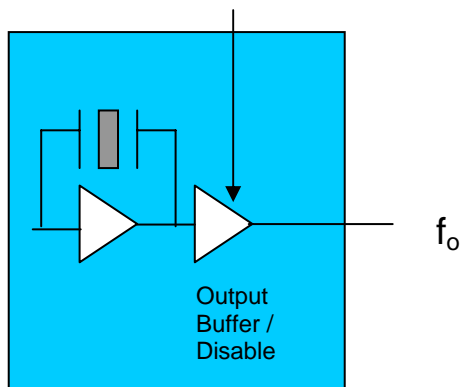

## VCA1 series 3.3, 5.0 volt CMOS Oscillator



The VCA1 Crystal Oscillator



### Features

- CMOS output
- Output frequencies to 160 MHz
- Tri-state output for board test and debug
- 0/70 or -40/85 °C operating temperature
- Product is compliant to RoHS directive  and fully compatible with lead free assembly

### Applications

- SONET/SDH/DWDM
- Ethernet, Gigabit Ethernet
- Storage Area Network
- Digital Video
- Broadband Access
- Microprocessors/DSP/FPGA

### Description

Vectron's VCA1 Crystal Oscillator (XO) is quartz stabilized square wave generator with a CMOS output, operating off a 3.3 or 5.0 volt supply.

The VCA1 uses fundamental or 3<sup>rd</sup> overtone crystals, for output frequencies < 80MHz, resulting in low jitter performance, typically 0.5ps rms in the 12 kHz to 20MHz band.

## Performance Characteristics

**Table 1. Electrical Performance, 5V option**

Parameter	Symbol	Min	Typical	Maximum	Units
Frequency	$f_O$	0.032768		160.000	MHz
Operating Supply Voltage <sup>1</sup>	$V_{DD}$	4.5	5.0	5.5	V
Absolute Maximum Supply Voltage		-0.7		7.0	V
Supply Current, Output Enabled 0.032768 to 2.0 MHz 2.01 to 30 MHz 30.01 to 50 MHz 50.01 to 160.00 MHz	$I_{DD}$			10 15 40 50	mA
Output Logic Levels Output Logic High <sup>2</sup> Output Logic Low <sup>2</sup>	$V_{OH}$ $V_{OL}$	$0.9 \cdot V_{DD}$		$0.1 \cdot V_{DD}$	V V
Output Rise/Fall Time <sup>2</sup> 0.032768 to 2.00 MHz 2.01 to 20.00 MHz 20.01 to 160.00 MHz	$t_R/t_F$			10 8 5	ns
Duty Cycle <sup>3</sup> (ordering option)	SYM	40/60 or 45/55			%
Operating Temperature (ordering option)	$T_{OP}$	0/70 or -40/85			°C
Storage Temperature	$T_{STOR}$	-55		125	°C
Stability <sup>4</sup> (ordering option)	$\Delta F/T$	$\pm 20, \pm 25, \pm 32, \pm 50, \pm 100$			ppm
Output Enable/Disable <sup>5</sup> Output Enabled Output Disabled	E/D	4.0		0.8	V
Start-up time	$T_{SU}$			10	ms

1. A 0.01 $\mu$ F and a 0.1 $\mu$ F capacitor should be located as close to the supply as possible (to ground) is recommended.
2. Figure 1 defines these parameters. Figure 2 illustrates the operating conditions under which these parameters are tested and specified.
3. Symmetry is measured defined as On Time/Period.
4. Includes calibration tolerance, operating temperature, supply voltage variations, aging and shock and vibration (not under operation).
5. Output will be enabled if enable/disable is left open.

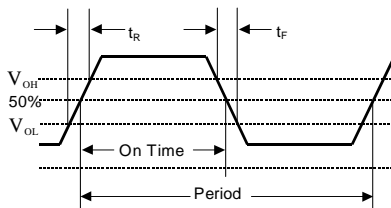

**Figure 1. Output Waveform**

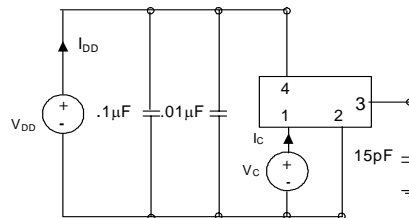

**Figure 2. Typical Output Test Conditions (25±5°C)**

# VCA1 Data Sheet

Table 2. Electrical Performance, 3.3V option					
Parameter	Symbol	Min	Typical	Maximum	Units
Frequency	$f_O$	0.032768		160.000	MHz
Operating Supply Voltage <sup>1</sup>	$V_{DD}$	2.97	3.3	3.63	V
Absolute Maximum Operating Voltage		-0.5		5.0	V
Supply Current, Output Enabled	$I_{DD}$				mA
0.032786 to 2.0 MHz				8	
2.01 to 30 MHz				10	
30.01 to 50 MHz				20	
50.01 to 160 MHz				35	
Output Logic Levels					
Output Logic High <sup>2</sup>	$V_{OH}$	$0.9 \cdot V_{DD}$			V
Output Logic Low <sup>2</sup>	$V_{OL}$			$0.1 \cdot V_{DD}$	V
Output Rise/Fall Time <sup>2</sup>	$t_{R/F}$				ns
0.032768 to 2.00 MHz				12	
2.01 to 20.00 MHz				10	
20.01 to 160.00 MHz				6	
Duty Cycle <sup>3</sup> (ordering option)	SYM		40/60 or 45/55		%
Operating Temperature (ordering option)	$T_{OP}$		0/70 or -40/85		°C
Storage Temperature	$T_{STOR}$	-55		125	°C
Stability <sup>4</sup> (ordering option)	$\Delta F/T$	$\pm 20, \pm 25, \pm 32, \pm 50, \pm 100$			ppm
Output Enable/Disable <sup>5</sup>	E/D				V
Output Enabled		2.0			
Output Disabled				0.5	
Start-up time	$T_{SU}$			10	ms

1. A 0.01 $\mu$ F and a 0.1 $\mu$ F capacitor should be located as close to the supply as possible (to ground) is recommended.
2. Figure 3 defines these parameters. Figure 4 illustrates the operating conditions under which these parameters are tested and specified. For  $f_O > 90$  MHz, rise and fall time is measured 20 to 80%.
3. Symmetry is measured defined as On Time/Period.
4. Includes calibration tolerance, operating temperature, supply voltage variations, aging and shock and vibration (not under operation).
5. Output will be enabled if enable/disable is left open.

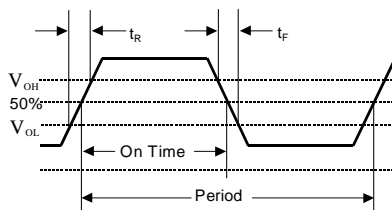

Figure 3. Output Waveform

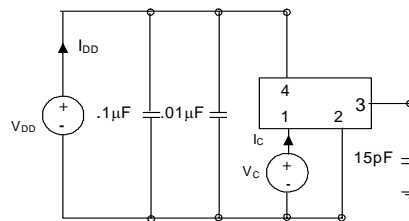

Figure 4. Typical Output Test Conditions (25±5°C)

### Enable/Disable Functional Description

Under normal operation the Enable/Disable is left open or set to a logic high state. When the E/D is set to a logic low, the oscillator stops and the output is in a high impedance state. This helps reduce power consumption as well as facilitating board testing and troubleshooting.

### Tri-state Functional Description

Under normal operation the tri-state is left open or set to a logic high state. When the tri-state is set to a logic low, the oscillator remains active but the output buffer is in a high impedance state. This helps facilitate board testing and troubleshooting.

### Table 3. Outline Diagrams and Pin Out

Pin #	Symbol	Function
1	E/D or NC	Tri-state, Enable/Disable or NC
2	GND	Electrical and Case Ground
3	$f_o$	Output Frequency
4	$V_{DD}$	Supply Voltage

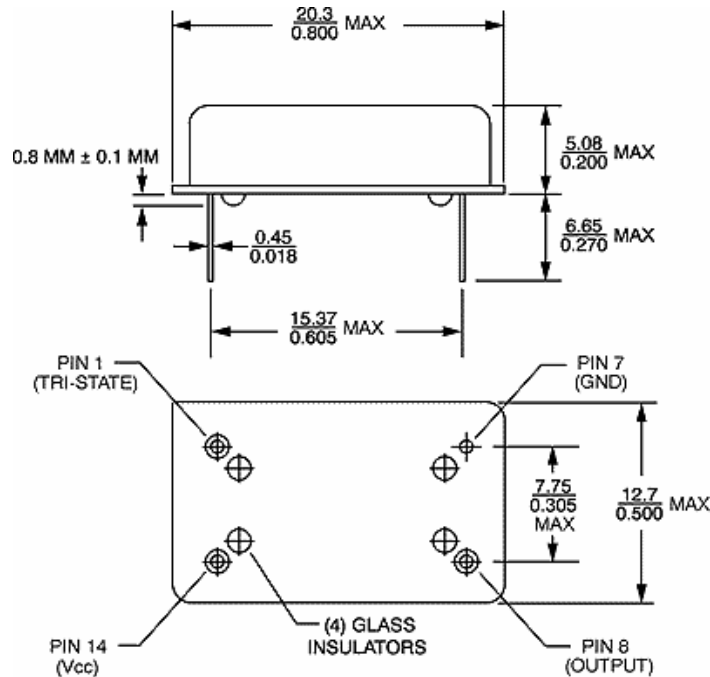

Figure 5, Package drawing

# VCA1 Data Sheet

## Reliability

The VCA1 qualification tests have included:

**Table 4. Environmental Compliance**

Parameter	Conditions
Mechanical Shock	MIL-STD-883 Method 2022
Mechanical Vibration	MIL-STD-883 Method 2007
Temperature Cycle	MIL-STD-883 Method 1010
Gross and Fine Leak	MIL-STD-883 Method 1014
Resistance to Solvents	MIL-STD-883 Method 2015

## Handling Precautions

Although ESD protection circuitry has been designed into the the VCA1, proper precautions should be taken when handling and mounting. VI employs a Human Body Model and a Charged-Device Model (CDM) for ESD susceptibility testing and design protection evaluation. ESD thresholds are dependent on the circuit parameters used to define the model. Although no industry wide standard has been adopted for the CDM, a standard HBM of resistance = 1.5kohms and capacitance = 100pF is widely used and therefore can be used for comparison purposes.

**Table 5. ESD Ratings**

Model	Minimum	Conditions
Human Body Model	1000	MIL-STD-883 Method 3115
Charged Device Model	1500	JESD 22-C101

## Suggested IR profile

Devices are built using lead free epoxy and can also be subjected to standard lead free IR reflow conditions, Table 6 shows max temperatures and lower temperatures. A peak temperature of 240°C minimum should be used to reflow the lead solder.

**Table 6. Reflow Profile (IPC/JEDEC J-STD-020B)**

Parameter	Symbol	Value
Preheat Time	$t_s$	150 sec Min, 200 sec Max
Ramp Up	$R_{UP}$	3 °C/sec Max
Time Above 217 °C	$t_L$	60 sec Min, 150 sec Max
Time To Peak Temperature	$t_{AMB-P}$	480 sec Max
Time At 260 °C (max)	$t_P$	10 sec Max
Time At 240 °C (max)	$t_{p2}$	60 sec Max
Ramp Down	$R_{DN}$	6 °C/sec Max

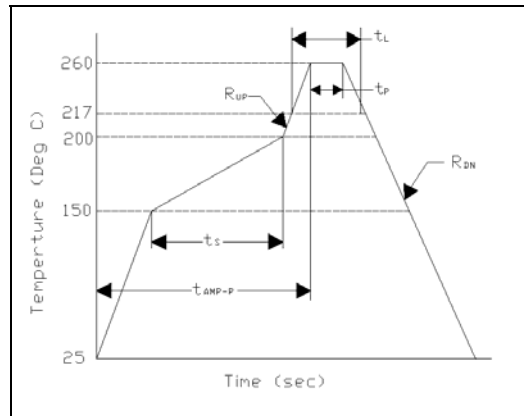

## VCA1 Data Sheet

### Ordering Information:

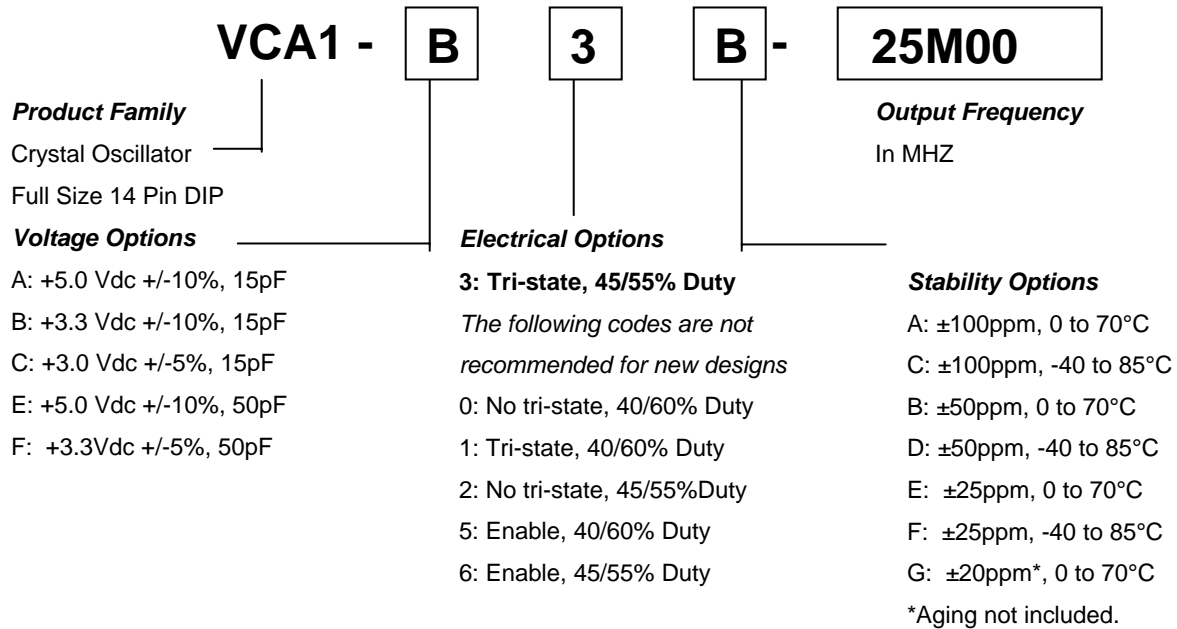

**Note: Not all combinations are available.**

*Tri-state with a 45/55% is the most common Electrical code and is recommended for most applications.*

*Devices will be shipped in Anti Static Tubes*

**For Additional Information, Please Contact:**



**USA:** Vectron International • 267 Lowell Road, Hudson, NH 03051  
• Tel: 1-88-VECTRON-1 • Fax: 1-888-FAX-VECTRON  
**EUROPE:** Landstrasse, D-74924, Neckarbischofsheim, Germany •  
Tel: 49 (0) 7268 8010 • Fax: 49 (0) 7268 801281  
**ASIA:** Vectron Asia Pacific Sales 1F~2F. No.8 Workshop No.308 Fenju Rd.,  
WaiGaoQiao Free Trade Zone, Pudong New Area Shanghai, China 200131  
•Tel: 8621 50480777 • Fax: 8621 50481881

[www.vectron.com](http://www.vectron.com)

July 24, 2006