

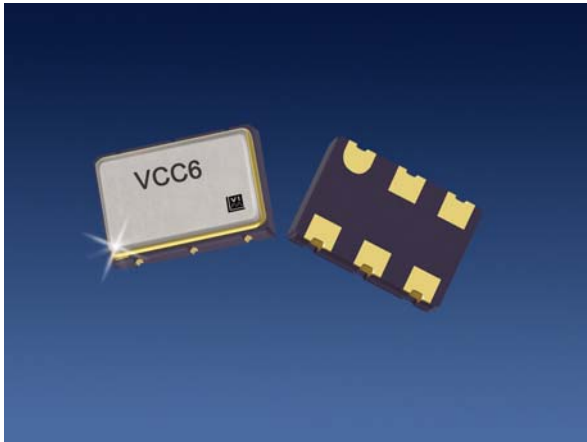

VCC6-Q/R Series 2.5 and 3.3 volt LVPECL Crystal Oscillator

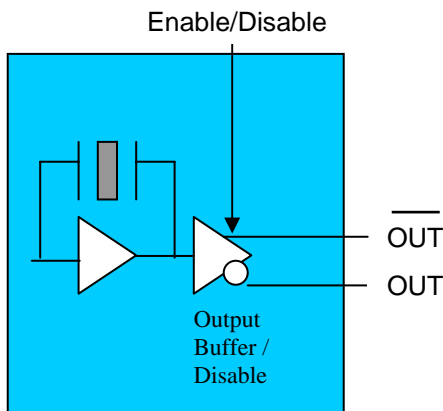

The VCC6 Crystal Oscillator



Features

- 2.5 or 3.3V LVPECL
- 3rd Overtone Crystal for best jitter performance
- Output frequencies to 270 MHz
- Low Jitter < 1 pS rms, 12kHz to 20MHz
- Enable/Disable for test and board debug
- -10/70 or -40/85 °C operating temperature
- Hermetically sealed ceramic SMD package
- Product is compliant to RoHS directive 

Applications

- SONET/SDH/DWDM
- Fiber Channel
- Ethernet, Gigabit Ethernet
- Storage Area Network
- Digital Video
- Broadband Access

Description

Vectron's VCC6 Crystal Oscillator (XO) is quartz stabilized square wave generator with a LVPECL output, operating off a 3.3 volt supply.

The VCC6 uses 3rd overtone crystals for frequencies under 200MHz, resulting in low jitter performance, typically 0.3pS rms in the 12 kHz to 20MHz band.

VCC6-Q/R Series, 2.5 and 3.3v PECL Crystal Oscillator

Performance Characteristics

Table 1. Electrical Performance

Parameter	Symbol	Min	Typical	Maximum	Units
Frequency	f_o	10		270	MHz
Supply Voltage ¹ , 3.3V Q option 2.5V R option	V_{DD}	3.15 2.375	3.3 2.5	3.45 2.625	V
Supply Current	I_{DD}			98	mA
Output Logic Levels, 0/70°C Output Logic High ² Output Logic Low ²	V_{OH} V_{OL}	$V_{DD}-1.025$ $V_{DD}-1.810$		$V_{DD}-0.880$ $V_{DD}-1.620$	V V
Output Logic Levels, -40/85°C Output Logic High ² Output Logic Low ²	V_{OH} V_{OL}	$V_{DD}-1.085$ $V_{DD}-1.830$		$V_{DD}-0.880$ $V_{DD}-1.555$	V V
Transition Times Rise Time ² Fall Time ²	t_R t_F			600 600	ps ps
Symmetry or Duty Cycle ³	SYM	45	50	55	%
Operating temperature (<i>ordering option</i>)	T_{OP}	-10/70 or -40/85			°C
Stability (<i>ordering option</i>) ⁴	$\Delta F/F$	±25, ±50 or ±100			ppm
Jitter, 12kHz to 20MHz ⁵ Cycle to Cycle, rms Cycle to Cycle, peak-peak Period Jitter, rms Period Jitter, peak-peak			0.3 4.8 38 2.7 23	0.7	pS
Output Enabled ⁶	V_{IH}	0.7* V_{DD}			V
Output Disabled ⁶	V_{IL}	0.3* V_{DD}			V
Output Enable/Disable time	$t_{E/D}$	200			nS
Enable/Disable Leakage Current	I_{IL}	±200			uA
Output Enable Pull-Up Resistor ⁶ Output Enabled Output Disabled			33 1		Kohm Mohm

1. A 0.01uF and a 0.1uF capacitor should be located as close to the supply as possible and terminated to ground.
2. Figure 1 defines these parameters. Figure 2 illustrates the operating conditions under which these parameters are tested and specified.
3. Symmetry is measured defined as On Time/Period.
4. Includes calibration tolerance, operating temperature, supply voltage variations, aging (40 degreesC/10 years) and shock and vibration (not under operation).
5. Measurements made on a VCC6-QAB-155M520 using an Agilent E5052A for phase noise and LeCroy 8600, 25K samples for jitter.
6. Output will be enabled if Enable/Disable is left open. The pull resistor changes to a higher value, operating in a "power saving mode" when Enable/Disable is set to a logic 0.

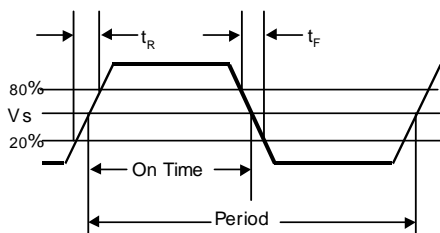

Figure 1. Output Waveform

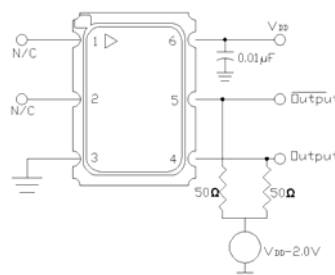

Figure 2. Typical Output Test Conditions (25±5°C)

VCC6-Q/R Series, 2.5 and 3.3v PECL Crystal Oscillator

Outline Diagram and Pin Out

Table 2. VCC6-QAx Pinout

Pin #	Symbol	Function
1	NC	This pin has no internal connection and is floating.
2	E/D	Enable/Disable Function
3	GND	Ground
4	f_o	Output Frequency
5	Cf_o	Complementary Output Frequency
6	V_{DD}	Supply Voltage

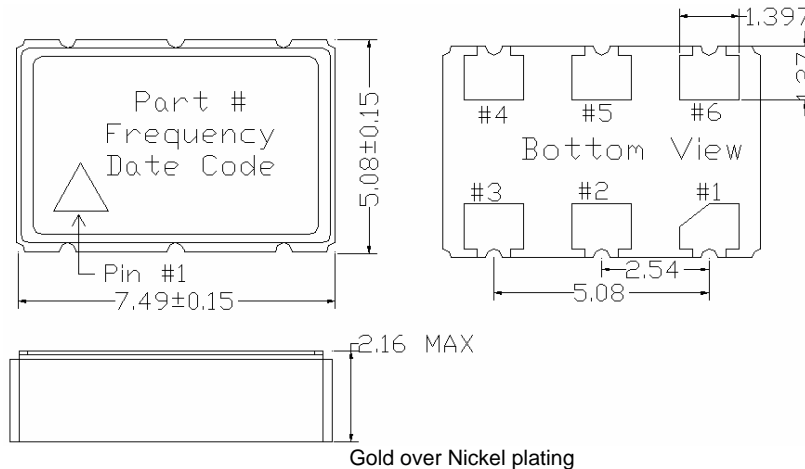

Figure 3 Optional VCC6-QAx Package Drawing

Table 3. VCC6-QCx Pinout

Pin #	Symbol	Function
1	E/D	Enable/Disable Function
2	NC	This pin has no internal connection and is floating.
3	GND	Ground
4	f_o	Output Frequency
5	Cf_o	Complementary Output Frequency
6	V_{DD}	Supply Voltage

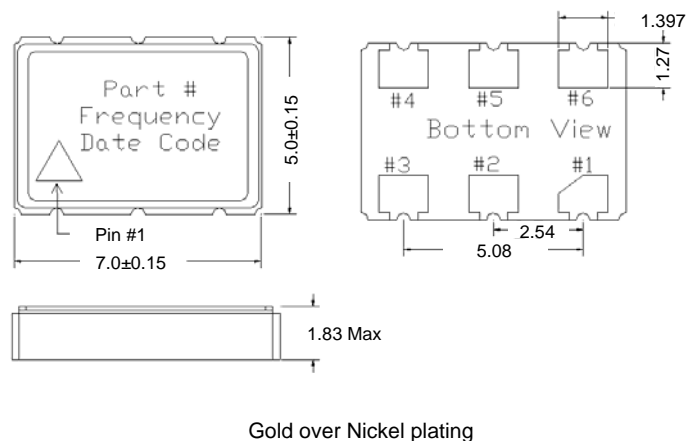

Figure 4. VCC6-QCx and VCC6-QAx Package Drawing

Terminating PECL Outputs

The VCC6 incorporates a standard PECL output scheme, which are un-terminated emitters as shown in Figure 5. There are numerous application notes on terminating and interfacing PECL logic and the two most common methods are a single resistor to ground, Figure 6, and a pull-up/pull-down scheme as shown in Figure 7. An AC coupling capacitor is optional, depending on the application and the input logic requirements of the next stage.

One of the most important considerations is terminating the Output and Complementary Outputs equally. An unused output should not be left un-terminated, and if one of the two outputs is left open it will result in excessive jitter on both. PC board layout must take this and 50 ohm impedance matching into account. Load matching and power supply noise are the main contributors to jitter related problems.

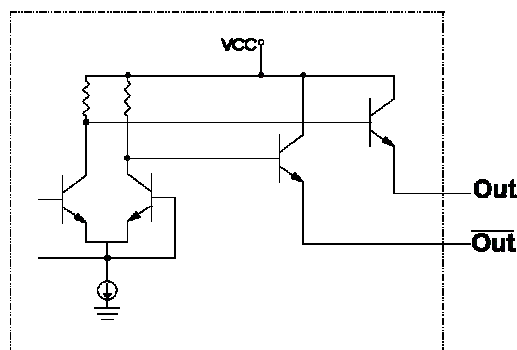

Figure 5. Standard PECL Output Configuration

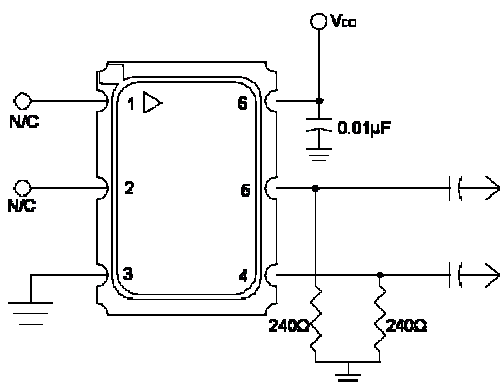

Figure 6. Single Resistor Termination
Resistor value are typically:
120 to 240ohms for 3.3V
82 to 120 ohms for 2.5V

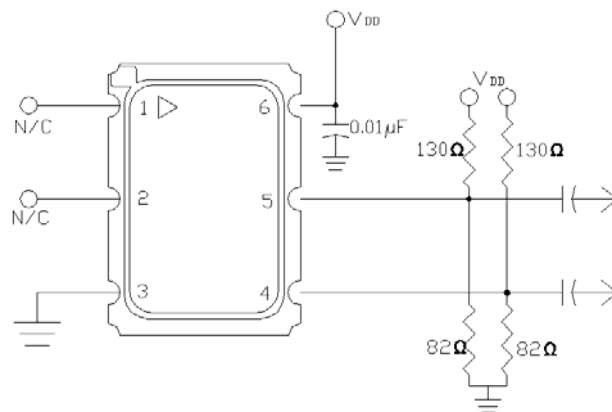

Figure 7. Pull-up Pull-down Termination
Resistor values are typically:
130 and 82 ohms for 3.3V
240 and 62 ohms for 2.5V

VCC6-Q/R Series, 2.5 and 3.3v PECL Crystal Oscillator

Enable/Disable Functional Description

Under normal operation the Enable/Disable is left open, or set to a logic high state, and the VCC6 is in oscillation mode and outputs are enabled (active). When the E/D is set to a logic low, the oscillator stops and the both the output and complementary outputs are in a high impedance state. This helps facilitate board testing and troubleshooting.

Power Saving Pull-Up Resistor

The E/D pull-up resistor changes in response to the input logic level; the pull-up resistor is a large value when E/D is set to a logic low, which reduces the current consumed. When E/D is open, or set to a logic high, the pull-up resistance becomes a smaller value which helps decrease the effects of external noise.

Absolute Maximum Ratings

Stresses in excess of the absolute maximum ratings can permanently damage the device. Functional operation is not implied at these or any other conditions in excess of conditions represented in the operational sections of this data sheet. Exposure to absolute maximum ratings for extended periods may adversely affect device reliability.

Table 4. Absolute Maximum Ratings

Parameter	Symbol	Ratings	Unit
Power Supply	V _{DD}	-0.5 to +7.0	Vdc
Enable/Disable	V _{IN}	-0.5 to V _{DD} +0.5	Vdc
Storage Temperature	T _{storage}	-55/125	°C

Reliability

The VCC6 qualification tests included:

Table 5. Environmental Compliance

Parameter	Conditions
Mechanical Shock	MIL-STD-883 Method 2002
Mechanical Vibration	MIL-STD-883 Method 2007
Solderability	MIL-STD-883 Method 2003
Gross and Fine Leak	MIL-STD-883 Method 1014
Resistance to Solvents	MIL-STD-883 Method 2016

Handling Precautions

Although ESD protection circuitry has been designed into the the VCC6, proper precautions should be taken when handling and mounting. VI employs a Human Body Model and a Charged-Device Model (CDM) for ESD susceptibility testing and design protection evaluation. ESD thresholds are dependent on the circuit parameters used to define the model. Although no industry wide standard has been adopted for the CDM, a standard HBM of resistance = 1.5kohms and capacitance = 100pF is widely used and therefore can be used for comparison purposes.

Table 6. ESD Ratings

Model	Minimum	Conditions
Human Body Model	1500	MIL-STD-883 Method 3015
Charged Device Model	1000	

VCC6-Q/R Series, 2.5 and 3.3v PECL Crystal Oscillator

IR Reflow and Suggested Pad Size Layout

The VCC6 has been qualified to meet the JEDEC standard for Pb-Free assembly. The temperatures and time intervals listed are based on the Pb-Free small body requirements and maximum parameters are listed in Table 6, lower temperatures are also acceptable. The VCC6 is hermetically sealed so an aqueous wash is not an issue. **Frequencies >200MHz will need to be reflowed at 220C max.**

Table 7. Reflow Profile (IPC/JEDEC J-STD-020)		
Parameter	Symbol	Value
PreHeat Time	t_s	60 sec Min, 200 sec Max
Ramp Up	R_{UP}	3 °C/sec Max
Time Above 217 °C	t_L	60 sec Min, 150 sec Max
Time To Peak Temperature	t_{AMB-P}	480 sec Max
Time At 260 °C (max)	t_P	40 sec Max
Time At 240°C (max)	$tp2$	60 sec MAX
Ramp Down	R_{DN}	6 °C/sec Max

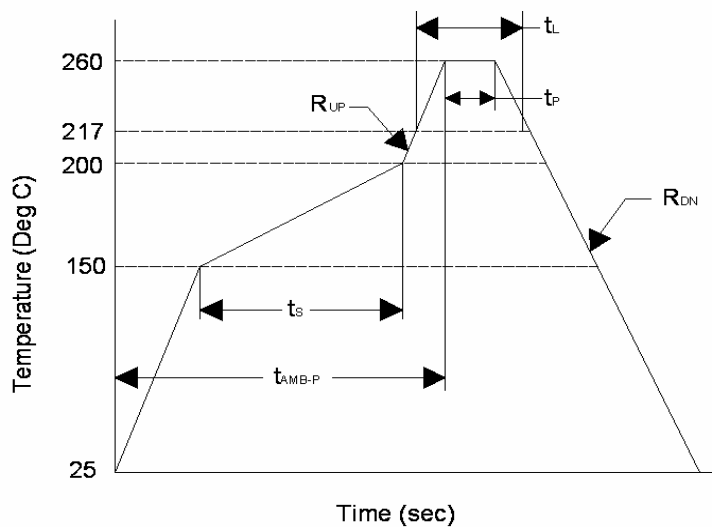

Figure 8. IR Reflow Diagram

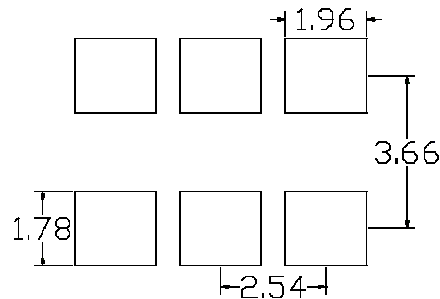

Figure 9. Pad Size Diagram

VCC6-Q/R Series, 2.5 and 3.3v PECL Crystal Oscillator

Tape and Reel

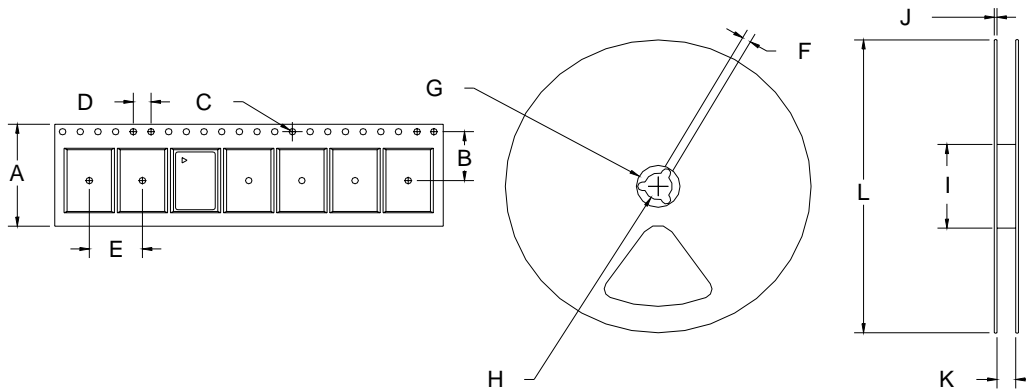

Figure 10. Tape and Reel Diagram

Table 8. Tape and Reel Dimensions (mm)													
Tape Dimensions					Reel Dimensions								# Per Reel
Product	A	B	C	D	E	F	G	H	I	J	K	L	Reel
VCC6	16	7.5	1.5	4	8	2	21	13	60	2	17	180	250

VCC6-Q/R Series, 2.5 and 3.3v PECL Crystal Oscillator

Table 9. Standard Frequencies (MHz)

19.440	27.000	27.027	35.000	37.000	38.880
40.000	40.680	48.000	50.000	52.300	62.500
64.000	64.375	74.1758	74.250	76.800	77.760
80.000	83.125	87.000	90.000	91.875	93.000
98.304	100.000	105.000	106.000	106.250	110.000
125.000	130.000	130.5882	133.000	134.560729	135.000
136.000	143.000	145.221	150.000	153.500	155.520
156.000	156.250	156.256	156.260	159.375	160.000
160.160	161.1328	163.235	164.3555	165.000	166.000
166.6286	166.6667	166.67	167.00	167.3316	168.200912
171.000	173.3707	175.000	180.000	187.500	190.000
195.3125	200.000	212.500	250.000	260.000	

Other frequencies may be available upon request. Standard frequencies are frequencies which the crystal has been designed and does not imply a stock position.

Ordering Information

VCC6-Qxx - xxMxxx

Product Family
Crystal Oscillator

Power Supply, Output
Q= 3.3V, LVPECL
R= 2.5V, LVPECL

Enable/Disable
A= E/D is on Pin 2, Pin 1 is a N/C
C= E/D is on Pin 1, Pin 2 is a N/C

Frequency

ex.: 125M000 = 125.000 MHz

Stability Options/Temperature

A= ±100 ppm, -10 to 70°C
B= ±50 ppm, -10 to 70°C
C= ±100 ppm, -40 to 85°C
D= ±50 ppm, -40 to 85°C
E= ±25 ppm, -10 to 70°C
F= ±25 ppm, -40 to 85°C
G* = ±20 ppm, -10 to 70°C

Note: Not all combinations of options are available.

A ±20 ppm option over -10 to 70°C 3.3V, VCC6-107-frequency, is also available

A ±20 ppm option over -10 to 70°C 2.5V, VCC6-110-frequency, is also available

* Indicates a code that does not include aging in the stability spec

For Additional Information, Please Contact:



www.vectron.com

USA: Vectron International • 267 Lowell Road, Hudson, NH 03051

• Tel: 1-88-VECTRON-1 • Fax: 1-888-FAX-VECTRON

EUROPE: Landstrasse, D-74924, Neckarbischofsheim, Germany •

Tel: 49 (0) 7268 8010 • Fax: 49 (0) 7268 801281

ASIA: Vectron Asia Pacific Sales 1F~2F. No.8 Workshop No.308 Fenju Rd., WaiGaoQiao Free Trade Zone, Pudong New Area Shanghai, China 200131

•Tel: 8621 50480777 • Fax: 8621 50481881

Vectron International reserves the right to make changes to the product(s) and/or information contained herein without notice. No liability is assumed as a result of their use or application. No rights under any patent accompany the sale of any such product(s) or information.

VCC6-Q/R (REVISION DATE: May 18, 2007)